



PVC WINDOWS

PVC TERRACE SYSTEMS

MADE WITH PASSION
AND EXPERIENCE



TABLE OF CONTENTS



PVC WINDOWS

IGLO ENERGY	
IGLO ENERGY CLASSIC	6
IGLO 5	
IGLO 5 CLASSIC	10
IGLO LIGHT	14
IGLO PREMIER	18
IGLO EXT	22

PVC TERRACE SYSTEMS

IGLO-HS	28
IGLO ENERGY PSK	
IGLO ENERGY CLASSIC PSK	32
IGLO 5 PSK	
IGLO 5 CLASSIC PSK	36
IGLO LIGHT PSK	40



ACCESSORIES

MUNTIN BARS	46	VENTILATION	58
BALCONY THRESHOLDS	48	COLOURS	60
HANDLES	50	GLASS PANES	62
NON-STANDARD DESIGNS	52	GLASS-PANE SPACERS	64
FITTINGS	54	RECTANGULAR GLAZING BEAD	65
RENOVATION AND ADAPTATION FRAMES	56	SMART HOME	66

INFORMATION

COMPARISON OF PVC SYSTEMS:	
- WINDOWS	68
- TERRACES	70
OTHER PRODUCTS	72
ABOUT US	78



PROFILE **SYSTEMS**
 **IGLO 5**
IGLO 5 CLASSIC

The common feature of both systems are 5 chambers, which provide very good thermal insulation performance. A wide package of additional options distinguishes our windows on the joinery market. Iglo 5 and Iglo 5 Classic are perfect for both warm and cold climates.



Smart Home



TECHNICAL DATA



70 mm

installation depth



$U_w 0,94 \text{ W(m}^2\text{K)}^*$

thermal transmittance



$R_w \text{ to } 44 \text{ dB}$

soundproofing



*More data at page 68-69.

SYSTEM STRUCTURE

The profile has a 5-chamber construction with an installation depth of 70 mm. It features steel reinforcement of the sash and frame. The window is fitted with a double EPDM gasket: external and internal.

D

IGLO 5

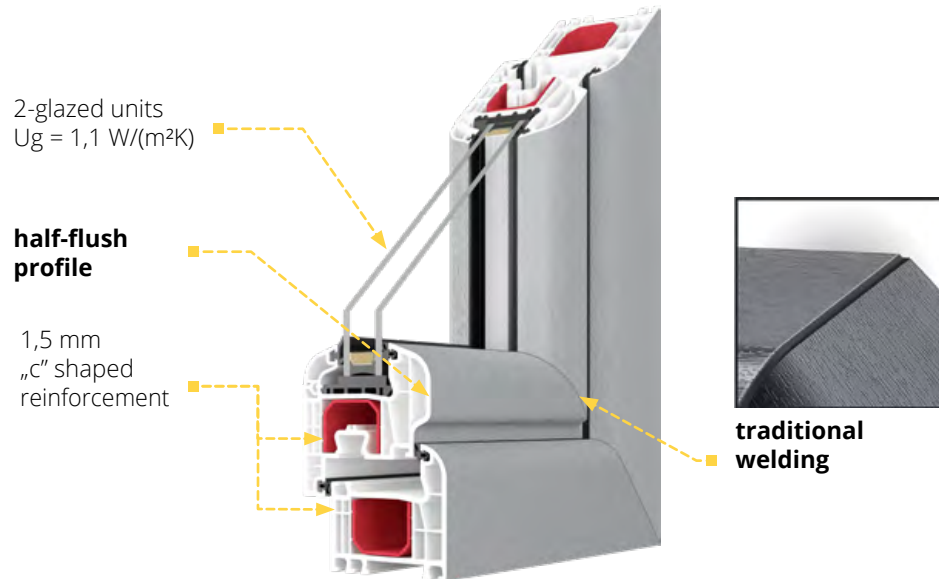

IGLO 5 CLASSIC

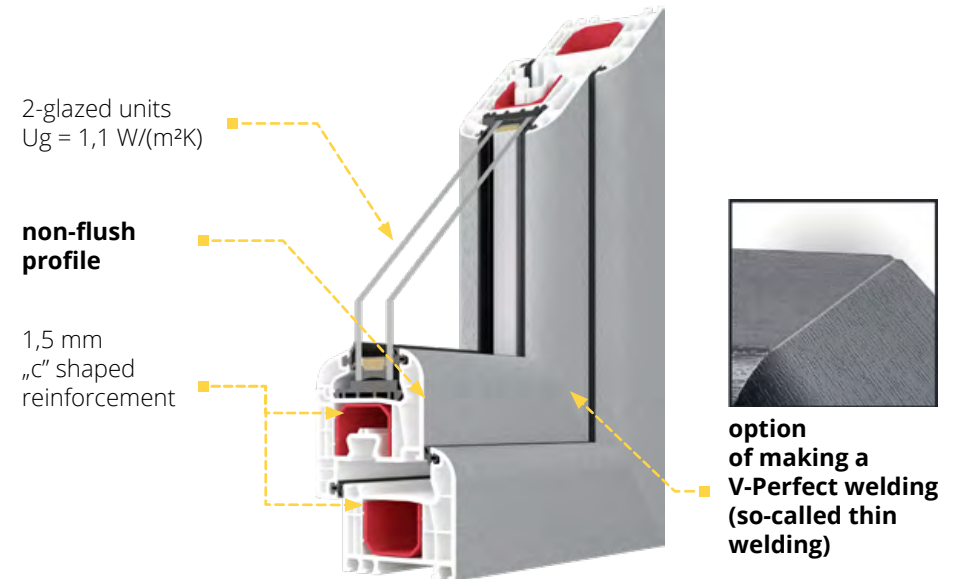























Standard:

- MACO MULTI-MATIC KS fittings with 2 anti-theft strikers with Silber-Look anticorrosion coating for long-lasting protection and smooth operation of the fitting
- sash lifter (lifting mishandling device - depending on window height)
- microventilation in tilt and turn windows
- hinge covers in 4 colours: white, silver, light brown, brown
- aluminium handle
- 2-glazed (1-chamber) units infilled with argon gas with $U_g = 1.1 \text{ W}/(\text{m}^2\text{K})$

- glass-pane spacer made of galvanised steel
- 2 EPDM gaskets in black (external and internal)
- gasket filling the lower fittings groove
- 1.5 mm steel reinforcement for frame and sash (2 mm for balcony door sash), „c”-shaped
- profile core in white
- 5-chamber PVC under-sill trim with gasket

ADDITIONAL OPTIONS

-  option of using glazed units with a thickness from 24 mm to 40 mm
-  option of using 3-glazed (2-chamber) units, infilled with argon gas, with $U_g = 0.6 \text{ W}/(\text{m}^2\text{K})$
-  option of using glass panes with improved sound insulation, laminated (safety and anti-burglary), ornamental, solar control, mirror and sandblasted
-  option of using the Swisspacer Ultimate glass-pane spacer, available in 3 colour variants: black, grey, brown (p. 64)
-  option of using MACO Multi-Power concealed hinges in the fittings groove (not visible when the window is closed), COMFORT, TBT, flat handles for roller blinds (only for PP, Iglo 5 Classic with DM 25 bolt)
-  wide range of colours of decorative films, option to cover the window on both sides (two the same or different colours) or only one side (p. 60)
-  option of selecting gaskets in grey
-  option of using a rectangular glazing bead - only for 24 mm glazing (p. 65)
-  handles for floating mullion windows
-  option of using full (closed) steel reinforcement in the frame
-  hinge covers in custom colours: titanium, champagne, cream, black and gold
-  turn lock
-  option of selecting a profile core in brown
-  option of making windows in V-Perfect technology (so called thin welding)
-  RC2 Resistance class can be achieved, 4 strikers, MAX fittings
-  MACO tilt mechanism
-  option of using ventilators (p. 58)
-  option of using 27 mm, 45 mm or 65 mm wide PVC glued on muntin bars and 8 mm, 18 mm, 26 mm or 45 mm wide aluminium internal muntin bars (p. 46)
-  available with roller shutters, Venetian blinds and mosquito nets (p. 74)
-  option of using a 41 mm and 65 mm high renovation frame and a 35 mm adaptation frame
-  option of providing Smart Home automation (p. 66)
-  wide range of additional profiles (connectors, extensions, sill profiles)



EXTRAS

A wide range of accessories enables you to fully personalise your windows and terrace systems. With us, you will create a window joinery that meets your expectations.

MUNTIN BARS

Create an elegant and yet unique look for your windows. The wide configuration options combined with the available colours make it possible to create many interesting arrangements.

Muntin bars can be used on all our window and terrace systems.

 *For the option of making a particular design from muntin bars, ask your dealer or contact Drutex's Technology Department.

GLUED-ON MUNTINS



PVC glued on muntin bars

Glued on muntin bar in widths of 27 mm, 45 mm or 65 mm. Available in our colour palette.

INSIDE GLASS MUNTINS



Internal aluminium muntin bars

Internal muntin bars in widths of 8 mm, 18 mm, 26 mm or 45 mm. Available colours: white, gold, silver, golden oak, dark oak, mahogany, nut, macore, winchester, RAL 8022 (ask your dealer for the other colours).



BALCONY THRESHOLDS

The balcony thresholds we offer are characterised by the highest ergonomics in use, durable construction and a high degree of thermal insulation. They are ideal for any climate zone.



WOODEN THRESHOLD

Available for:

- IGLO 5
- IGLO LIGHT
- IGLO 5 CLASSIC
- IGLO EXT

OPTIONAL THRESHOLDS FOR IGLO ENERGY and IGLO ENERGY CLASSIC



COMBI 20 MM



COMBI PLAN 0,0 MM

with a possibility of providing a linear drainage system (optional)



FRAME THRESHOLD - STANDARD FOR EVERY SYSTEM

- IGLO ENERGY
- IGLO ENERGY CLASSIC
- IGLO 5
- IGLO 5 CLASSIC
- IGLO EXT
- IGLO LIGHT

20 MM ALUMINIUM THRESHOLD

Available for:

- IGLO 5
- IGLO 5 CLASSIC
- IGLO LIGHT
- IGLO EXT



HANDLES

The handles used in our products are made of aluminium and are distinguished not only by their elegant design the colour options, but also by their ergonomic shape. Handles can be supplied with options with a key or push-button to prevent unintentional opening (an option particularly recommended for children's rooms).

ALUMINIUM WINDOW AND BALCONY DOOR HANDLES

IGLO 5 STANDARD WINDOW HANDLE



IE WINDOW HANDLE



IGLO 5 WINDOW HANDLE WITH KEY



DUBLIN WINDOW HANDLE



DUBLIN WINDOW HANDLE WITH PUSH-BUTTON



DUBLIN WINDOW HANDLE WITH KEY



DOUBLE-SIDED BALCONY DOOR HANDLE WITH PZ-PLATE FOR ROLLER SHUTTER¹



HANDLE FOR BALCONY DOOR BOLT FOR ROLLER SHUTTER²



HANDLE FOR BALCONY DOOR BOLT²



Available in: white, silver, olive and brown.



¹ Available for Iglo 5 Classic with DM 25 bolt, Iglo PP (intermediate profile)

² Also available in black (RAL 9005)



STANDARD HANDLE FOR
PSK SYSTEM



HANDLE WITH AUTOMATIC
FOR PSK SYSTEM



HANDLES FOR IGLO - HS SYSTEM

STANDARD



WITH SINGLE-SIDED INSERT



DOUBLE-SIDED BALCONY
DOOR HANDLE WITH PZ
PLATE³



WITH DOUBLE-SIDED INSERT



³ Available for Iglo EXT, Iglo 5 Classic with DM 25 bolt

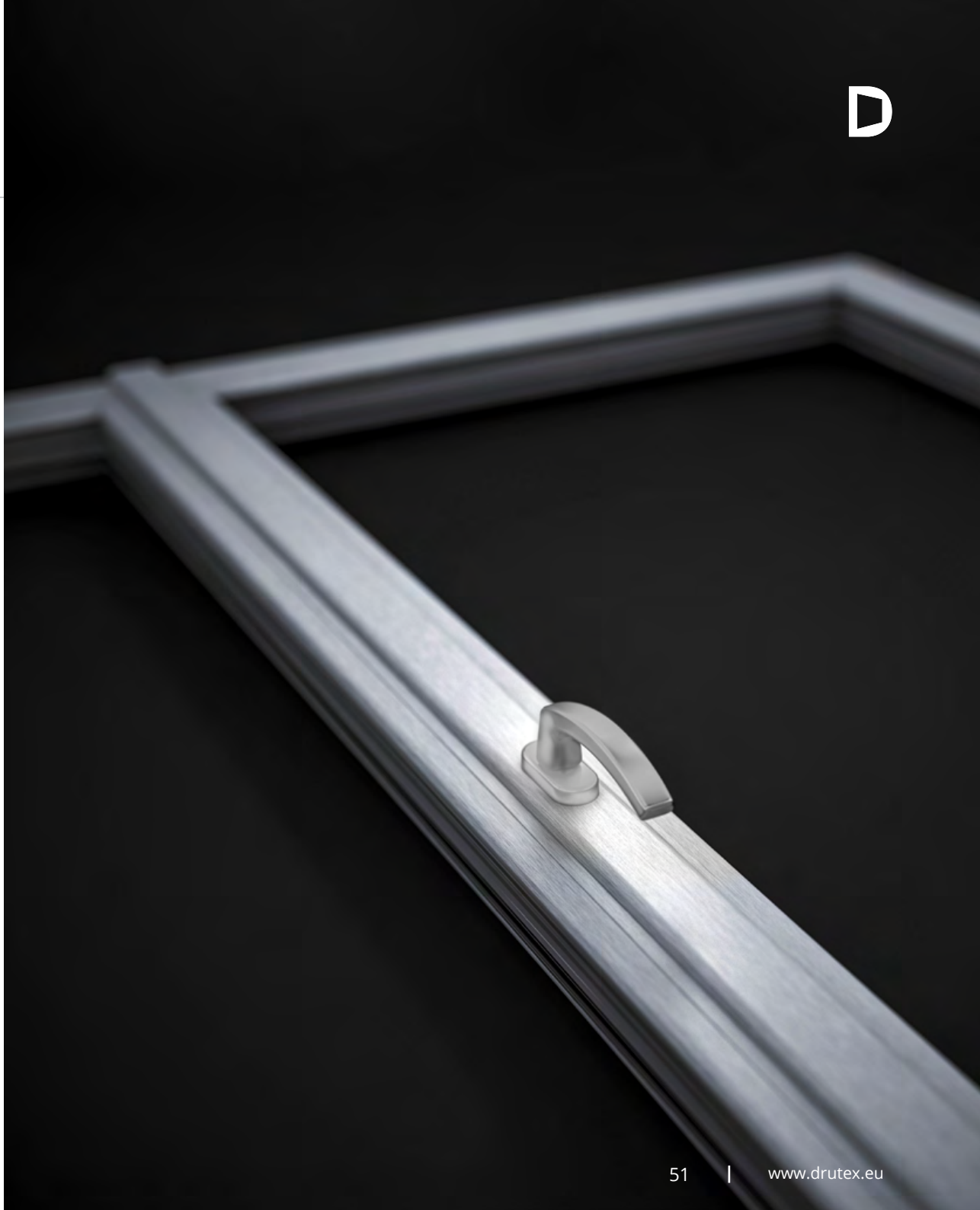

NON-STANDARD DESIGNS

We also offer non-standard window designs in systems:

- IGLO ENERGY
- IGLO ENERGY CLASSIC
- IGLO 5
- IGLO 5 CLASSIC
- IGLO LIGHT

For confirmation of a non-standard design, contact your dealer or Drutex's Technology Department.



In non-standard designs, there is no option for V-Perfect welding (so-called thin welding), due to the lack of a 90° angle in all corners.



CREATE YOUR OWN UNIQUE STYLE

D



FITTINGS

The fittings used by DRUTEX are the perfect solution in terms of security and functionality of the window and door joinery.

In addition, there is an option of:

- use of concealed hinges
- use of fittings that meet the requirements for anti-burglary in the RC2 and RC2 N class



MOUNTING WEDGES

Option of ordering mounting wedges used to level window and door frames during the installation.



STANDARD HINGES

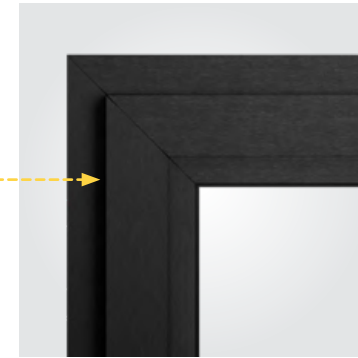

CONCEALED HINGES
invisible when window is closed



TRANSOM WINDOW LOCK
allows the transom window to be opened or closed mechanically in places that are difficult to access (e.g. due to the height of the transom window).



REED SWITCH
magnetic window and door opening sensor is a part of the Smart Home access control system or alarm system



FRICTION BRAKE
protects against spontaneous opening or closing of window and door sashes



GRADUAL TILT MECHANISM
allows the window to be tilted in 5 positions



COMFORT FITTINGS
handle in the bottom part of the window sash



TBT (TILT BEFORE TURN) FITTINGS
tilt position before opening - key protection against full opening of the window

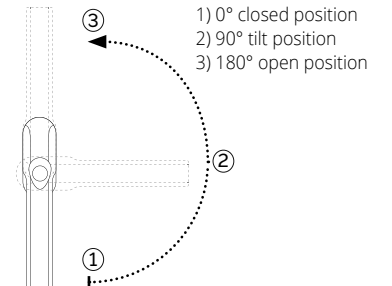



HINGE COVERS¹



ALUMINIUM
BALCONY DOOR
PULL-HANDLE²

1) Colours available:

2) Colours available:

Standard:

- white
- brown
- light brown
- silver

- white, RAL 9016,
- silver, RAL 9006,
- brown RAL 8019,
- RAL 1036,
- RAL 7016

as an additional option:

- black
- gold-look
- titanium
- champagne
- cream



- MACO Multi-Power concealed fittings invisible when the window is closed
- Load capacity up to 150 kg

RENOVATION AND ADAPTATION FRAMES

The use of a renovation frame allows windows to be installed without removing the old window frames. This solution is successfully used in historic buildings or where exceptional care is required for the building façade. Available in the colours of our veneer colour palette.



 The option of making a renovation and adaptation frame in V-Perfect technology (so-called thin welding):

- Iglo Energy Classic
- Iglo 5 Classic
- Iglo Light
- Iglo Premier
- Iglo EXT

IGLO 5 50004

height: 41 mm

RENOVATION FRAME:

- IGLO 5
- IGLO 5 CLASSIC
- IGLO LIGHT
- IGLO PREMIER
- IGLO EXT

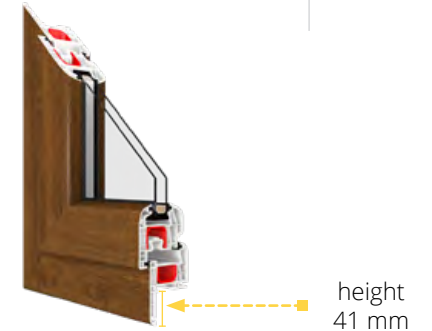

IGLO 5 50005

height: 65 mm

RENOVATION FRAME:

- IGLO 5
- IGLO 5 CLASSIC
- IGLO LIGHT
- IGLO PREMIER
- IGLO EXT



IGLO ENERGY 70004

height: 47 mm

RENOVATION FRAME:

- IGLO ENERGY
- IGLO ENERGY CLASSIC

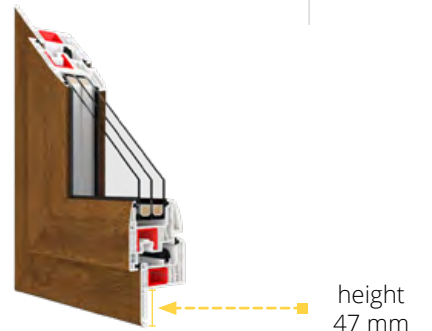



IGLO 5 50009

height: 35 mm

ADAPTATION FRAME:

IGLO 5
 IGLO 5 CLASSIC
 IGLO LIGHT
 IGLO PREMIER
 IGLO EXT



IGLO ENERGY 70009

height: 35 mm

ADAPTATION FRAME:

IGLO ENERGY
 IGLO ENERGY CLASSIC

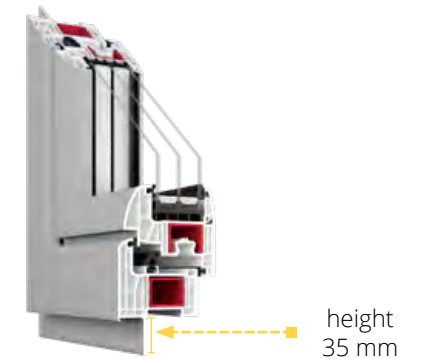

VENTILATION

Aiming at providing the highest living comfort, Drutex offers high-quality ventilators that ensure proper ventilation and fresh air when the windows are tightly closed.

 For the application of ventilation in PSK systems, consult the DRUTEX's Technology Department.

INTERNAL VIEW

6-30 m³/h*



Aereco AMO pressure ventilator

1) Available colours:

- white,
- RAL: 8001, 8017, 7016.

6,2-22 m³/h*



Ventair Simpess pressure ventilator

1) Available colours:

- white,
- RAL: 8003, 8017.

7-28 m³/h*



Aereco EXR acoustic hygro-regulated ventilator

1) Available colours:

- white,
- RAL: 8001, 8017, 7016, 7045.

5-29 m³/h*



Aereco EMM hygro-regulated ventilator

1) Available colours:

- white,
- RAL: 8001, 8017, 7016, 7045.

*Measured at 10 Pa - data obtained from the ventilator manufacturer.

BENEFITS OF USING VENTILATORS:

- modern, natural and healthy ventilation
- improved air exchange
- thermal comfort in the room (no feeling of draught as with tilted windows)
- possibility of adjusting the air flow in accordance with the weather conditions
- reducing the risk of damp rooms and the fungal and mould growth
- security
- Wide range of options: wooden windows, PVC windows, aluminium windows.



5,2 m³/h*

Radaks

Available colours: white (gaskets in black or grey).



5,6 m³/h*

Regel - air

Available colours: white (gaskets in black or grey).



6,5 m³/h*

Maco Vent

Available colours: white (gaskets in black or grey).



46,5 m³/h*

RENSON THM 90 ventilator with a drip cap

Available colours:
 - RAL: 7016, 8019, 9005, 9006, 9016,
 - Ask your dealer or our sales department about custom colours.

Radaks, Regel - air and Maco Ventyl ventilators are not available for the Iglo Premier and Iglo EXT windows.

*Measured at 10 Pa - data obtained from the ventilator manufacturer.



RENSON THM 90



COLOURS

The rich colour range of window, balcony doors, HS and PSK terrace systems allows almost unlimited options for colour matching to customers' personal needs and preferences. The excellent quality of the foils used during production guarantees that the highest quality and durability of the colour will be maintained for many years.

FOILS REFERENCE COLOURS

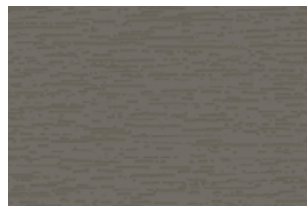

Concrete grey
702305-167

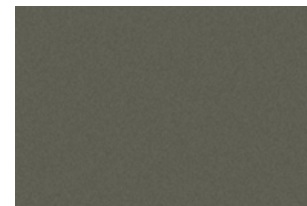

Basalt grey smooth
701205-097



Crown Platinum
9.1293001-195



Light grey
725105-167

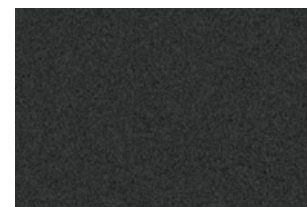

Anthracite Ulti-Matt
02.20.71.000001-504700



Quartz grey smooth
703905-097

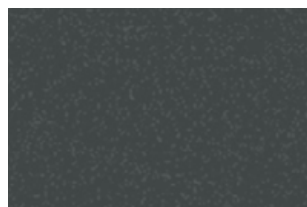

Slate
1.0065002-097



Slate grey smooth
02.11.71.000040-097



Black Ulti-Matt
02.20.01.000002-504700



Cream
137905-167



Quartzite grey
703905-167



Dark red
308105-167



Moss green
600505-167



FX white
915205-168



Anthracite
701605-167



Chocolate brown
887505-167



Natural oak
T3118076-167



Oregon
2115008-167



Rosewood
851805-167



Douglas fir
3152009-167

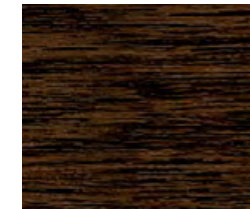

Dark oak
2052089-167

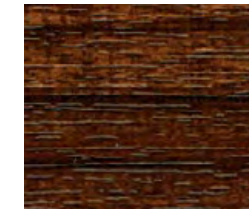

Macore
3162002-167

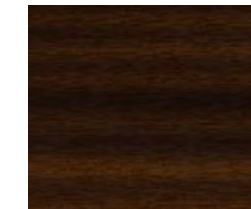

Mahogany
2097013-167



Grey
715505-167



Smooth anthracite
701605-097



Golden oak
2178001-167



Basalt grey
70125-097

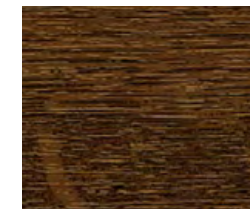

Nut
2178007-167

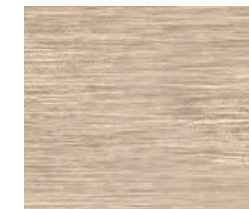

Sheffield oak light
F 456-3081

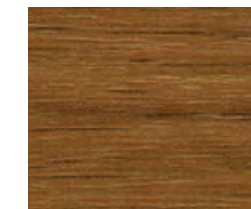

Winchester
49240015-148



Dark green
612505-167

GLASS PANES

We offer many types of glass panes that are characterised by the highest quality of workmanship. Choose panes for your windows that will meet your expectations and give your interior unique character.

We have been manufacturing multiple glazed panes since 1994. We have a state-of-the-art glass tempering plant and our own research laboratories, which ensure the highest quality.

The glazed units we manufacture can be fitted with special capillaries to equalise the pressure inside the glass with atmospheric pressure. Thanks to this solution, the glazing packages will perform perfectly in your premises.



Option to sandblast the glass in any way you wish (in 3 shades of grey)* or to use ready-made designs.

INFILLING MATERIAL

- **ARGON** - all glazed units are infilled with argon gas as standard, which guarantees very good thermal insulation. This has resulted in glazed units with U_g value of between 1.1 and 0.5 $W/(m^2K)$.
- **KRYPTON** - on special request, the glazed units can be infilled with krypton gas, which ensures an excellent thermal insulation parameter of $U_g = 0.3 W/(m^2K)$. Such a solution can be used with 4-pane (3-chamber) units dedicated to the systems: IGLO ENERGY, IGLO ENERGY CLASSIC, IGLO ENERGY PSK, IGLO ENERGY CLASSIC PSK and IGLO-HS.



3-pane (2-chamber) 48 mm units with glass-pane spacer made of galvanised steel.



RODZAJE SZYB



Matt



Striped sandblasted glass*



Reflect-float brown 6 mm



Reflect-float blue 6 mm



Float 4, 6, 8, 10 m

Thermal coating option.



Laminated glass

Thermal coating option.



Chinchilla ornament



Delta ornament



Silvit ornament

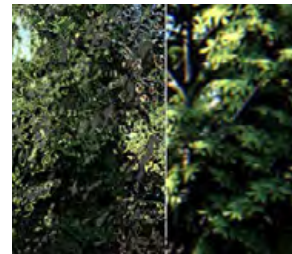

Cathedral ornament



Master Carre ornament

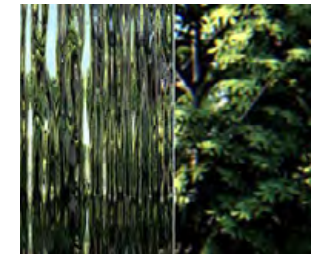

Rain ornament



Antisol green



Antisol brown



Antisol grey



Antisol blue



Mirastar

* For sandblasting, contact Drutex's Technology Department or ask your dealer.

GLASS-PANE SPACERS

The glass-pane spacers contribute to the thermal insulation of the glazed units. Drutex already offers glass-pane spacer made of galvanised steels as a standard, which are characterised by very good thermal insulation, much better than aluminium spacers. The Swisspacer Ultimate plastic spacer is available as an option.

Glass-pane spacer made of galvanised steel is provided as standard with every glazed unit.

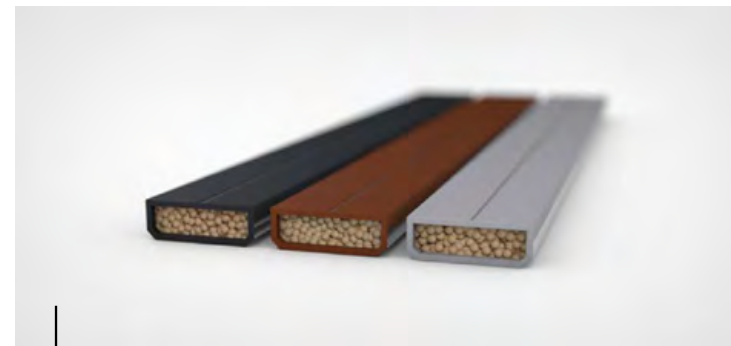

Swisspacer Ultimate

Optional Swisspacer Ultimate glass-pane spacer available in black, brown, grey.

RECTANGULAR GLAZING BEAD

The rectangular glazing bead is dedicated to the window, balcony and terrace systems. In combination with the latest decorative veneers imitating aluminium, windows fit in with the latest architectural trends.

Option available for glazing:

48 mm

- Iglo Energy
- Iglo Energy PSK
- Iglo Energy Classic
- Iglo Energy Classic PSK

36 mm

- Iglo-HS

24 mm

- Iglo 5 / Iglo 5 PSK
- Iglo 5 Classic / Iglo 5 Classic PSK
- Iglo Light / Iglo Light PSK
- Iglo Premier
- Iglo EXT

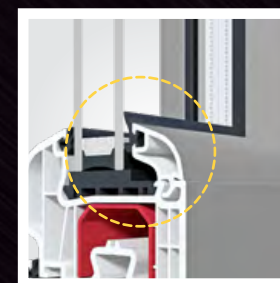

STANDARD
GLAZING BEAD

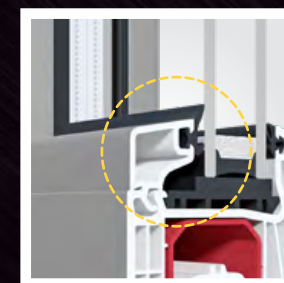

RECTANGULAR
GLAZING BEAD

SMART HOME WITH EVERYTHING UNDER CONTROL

Intelligent control systems for window automation via remote control, tablet or smartphone are becoming increasingly popular with customers, allowing the system to also be managed remotely while they are away.

There is the option of opening and closing windows individually, in groups as well as time-based programming and connection to other intelligent systems in the house.

This is an investment in comfort and functionality at the highest level.

G - U AUTOMATICS

A modern system designed for HS system solutions.

Functions:

- opening and closing
- operation via remote control and/or smartphone app

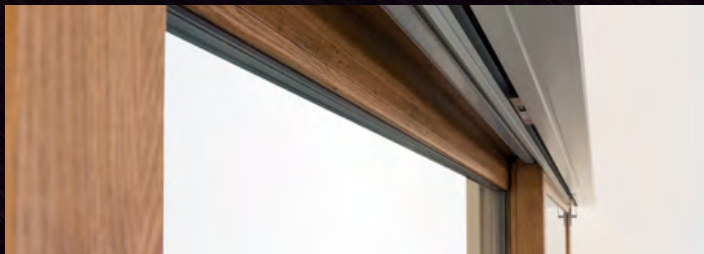

TaHoma® switch

Windows, doors, roller shutters, Venetian blinds, gates and wickets that, thanks to the intelligent control unit from Somfy - TaHoma® switch, can open or close by themselves at selected times of the day, can tilt or slide in integrated groups or individually, offering us full control and surveillance of our home, even when we are not inside. The TaHoma® switch also allows us to manage the lighting in the house and garden.



BleBox product line

These are miniature devices that allow you to open and close doors, windows, roller shutters, awnings, Venetian blinds, gates, manage lighting or the alarm system via your smartphone and tablet - even from anywhere in the world.





COMPARISON OF PVC WINDOW SYSTEMS



INFORMATION

IGLO ENERGY

IGLO ENERGY CLASSIC

IGLO 5

THERMAL INSULATION U_w	$U_w = 0,79 \text{ W/(m}^2\text{K)}^1$	$U_w = 0,81 \text{ W/(m}^2\text{K)}^2$	$U_w = 0,94 \text{ W/(m}^2\text{K)}^3$
NUMBER OF CHAMBERS IN THE PROFILE	7	7	5
SOUND INSULATION dB	dB = 36-46	dB = 36-46	dB = 36-44
PROFILE CORE COLOUR 1 - STANDARD 2 - OPTION	1 - white 2 - brown	1 - white 2 - brown, anthracite	1 - white 2 - brown
RENOVATION FRAME HEIGHT	47 mm	47 mm	41 mm or 65 mm
GLAZED UNITS AS STANDARD	$U_g = 0.5 \text{ W/(m}^2\text{K)}$ 3-pane (2 chamber) units, infilled with argon gas, glass-pane spacer made of galvanised steel	$U_g = 0.5 \text{ W/(m}^2\text{K)}$ 3-pane (2 chamber) units, infilled with argon gas, glass-pane spacer made of galvanised steel	$U_g = 1.1 \text{ W/(m}^2\text{K)}$ 2-pane (1 chamber) units, infilled with argon gas, glass-pane spacer made of galvanised steel
GLAZING THICKNESS MIN. - MAX.	24 - 48 mm	24 - 48 mm	24 - 40 mm
PROFILE DEPTH/ HEIGHT 1 - FRAME 2 - SASH	1 - 82 mm / 74 mm 2 - 95,9 mm / 86 mm	1 - 82 mm / 74 mm 2 - 82 mm / 86 mm	1 - 70 mm / 66 mm 2 - 80 mm / 78 mm
STEEL REINFORCEMENT 1 - FRAME 2 - SASH	1 - 2 mm full (closed) 2 - 2 mm „c“-shaped	1 - 2 mm full (closed) 2 - 2 mm „c“-shaped	1 - 1.5 mm „c“-shaped 1 -2- 1.5 mm (2 mm on balcony doors) „c“-shaped
BALCONY THRESHOLD 1 - STANDARD 2 - OPTION	1 - jamb frame 2 - Combi Plan 0.0 mm, Combi Plan 0.0 mm with linear drainage system or Combi 20 mm	1 - jamb frame 2 - Combi Plan 0.0 mm, Combi Plan 0.0 mm with linear drainage system or Combi 20 mm	1 - jamb frame 2 - 20 mm aluminium threshold or wooden threshold

1) For a window size of 1230x1480 mm – CSI (Czech Republic) $U_w = 0.79 \text{ W/(m}^2\text{K)}$ with steel reinforcement and glazed units $U_g = 0.5 \text{ W/(m}^2\text{K)}$ infilled with argon gas, with Swisspacer plastic spacer.

2) For a window size of 1230x1480 mm – CSI (Czech Republic) $U_w = 0.81 \text{ W/(m}^2\text{K)}$ with steel reinforcement and glazed units $U_g = 0.5 \text{ W/(m}^2\text{K)}$ infilled with argon gas, with Swisspacer plastic spacer.

3) For a window size of 1230x1480 mm – CSI (Czech Republic) $U_w = 0.94 \text{ W/(m}^2\text{K)}$ with steel reinforcement and glazed units $U_g = 0.5 \text{ W/(m}^2\text{K)}$ infilled with argon gas, with Swisspacer plastic spacer.



IGLO 5 CLASSIC



IGLO LIGHT



IGLO PREMIER



IGLO EXT

Uw = 0,94 W/(m²K) ⁴	Uw = 1,0 W/(m²K) ⁵	Uw = 0,89 W/(m²K) ⁶	Uw = 0,89 W/(m²K) ⁶
5	5	5	5
dB = 36-44	dB = 36-44	-	-
1 - white 2 - brown	1 - white	1 - white	1 - white
41 mm or 65 mm	41 mm or 65 mm	41 mm or 65 mm	41 mm or 65 mm
Ug = 1.1 W/(m²K) 2-pane (1 chamber) units, infilled with argon gas, glass-pane spacer made of galvanised steel	Ug = 1.1 W/(m²K) 2-pane (1 chamber) units, infilled with argon gas, glass-pane spacer made of galvanised steel	Ug = 1.1 W/(m²K) 2-pane (1 chamber) units, infilled with argon gas, glass-pane spacer made of galvanised steel	Ug = 1.1 W/(m²K) 2-pane (1 chamber) units, infilled with argon gas, glass-pane spacer made of galvanised steel
24 - 40 mm	24 - 40 mm	24 - 40 mm	24 - 40 mm
1 - 70 mm / 66 mm 2 - 70 mm / 78 mm	1 - 70 mm / 66 mm 2 - 70 mm / 70 mm	1 - 70 mm / 66 mm 2 - 70 mm / 78 mm	1 - 70 mm / 66 mm 2 - 70 mm / 78 mm
1 - 1.5 mm „c“-shaped 2- 1.5 mm (2 mm on balcony doors), „c“-shaped	1 - 1.5 mm „c“-shaped 1 -2- 1.5 mm (2 mm on balcony doors) „c“-shaped	1 - 1.5 mm full (closed) 2- 1.5 mm specially designed profile	1 - 1.5 mm full (closed) 1 -2- 1.5 mm (2 mm on balcony doors) „c“-shaped
1 - jamb frame 2 - 20 mm aluminium threshold or wooden threshold	1 - jamb frame 2 - 20 mm aluminium threshold or wooden threshold	1- jamb frame	1 - jamb frame 2 - 20 mm aluminium threshold or wooden threshold

4) For a window size of 1230x1480 mm – CSI (Czech Republic) Uw = 0.94 W/(m²K) with steel reinforcement and glazed units Ug = 0.6 W/(m²K) infilled with argon gas, with Swisspacer plastic spacer.

5) For a window size of For a window size of 1230x1480 mm - ift Rosenheim Uw = 1.0 W/(m²K) with steel reinforcement, for glass pane with Ug = 0.6 W/(m²K) infilled with argon gas, with Swisspacer plastic spacer.

6) For a window size of 1230x1480 mm - calculation method = 0.89 W/(m²K) with steel reinforcement and glazed units Ug = 0.6 W/(m²K) infilled with argon gas, with a Swisspacer plastic spacer.

COMPARISON OF PVC TERRACE SYSTEMS



IGLO-HS



IGLO ENERGY PSK



IGLO ENERGY CLASSIC PSK

INFORMATION

THERMAL INSULATION U_w	$U_w = 0,71 \text{ W}/(\text{m}^2\text{K})^1$	$U_w = 0,66 \text{ W}/(\text{m}^2\text{K})^2$	$U_w = 0,66 \text{ W}/(\text{m}^2\text{K})^2$
NUMBER OF CHAMBERS IN THE PROFILE	7	7	7
PROFILE CORE COLOUR 1 - STANDARD 2 - OPTION	1 - white	1 - white 2 - brown	1 - white 2 - brown, anthracite
V-PERFECT WELDING OPTION	yes	no	yes
GLAZED UNITS AS STANDARD	$U_g = 0,5 \text{ W}/(\text{m}^2\text{K})$ 3-pane (2 chamber) units, infilled with argon gas, glass-pane spacer made of galvanised steel	$U_g = 0,5 \text{ W}/(\text{m}^2\text{K})$ 3-pane (2 chamber) units, infilled with argon gas, glass-pane spacer made of galvanised steel	$U_g = 0,5 \text{ W}/(\text{m}^2\text{K})$ 3-pane (2 chamber) units, infilled with argon gas, glass-pane spacer made of galvanised steel
GLAZING THICKNESS MIN. - MAX.	36 - 52 mm	24 - 48 mm	24 - 48 mm
PROFILE DEPTH/ HEIGHT 1 - FRAME 2 - SASH	1 - 194 mm / 74 mm 2 - 82 mm / 98 mm	1 - 82 mm / 74 mm 2 - 95,9 mm / 86 mm	1 - 82 mm / 74 mm 2 - 95,9 mm / 86 mm
STEEL REINFORCEMENT 1 - FRAME 2 - SASH	1 - 3 mm, „c“-shaped 2 - 2 mm full (closed)	1 - 2 mm full (closed) 2 - 2 mm „c“-shaped	1 - 2 mm full (closed) 2 - 2 mm „c“-shaped
FITTINGS 1 - STANDARD 2 - OPTION	G-U with 3 locking bolts	1 - MACO SKB-S Standard System 2 - MACO SKB-Z Automatic System	1 - MACO SKB-S Standard System 2 - MACO SKB-Z Automatic System
THRESHOLD	system threshold	jamb frame	jamb frame

1) Calculation method: Terrace system of size 5000x2500 mm, with steel reinforcement and glazed units $U_g = 0,5 \text{ W}/(\text{m}^2\text{K})$ infilled with argon gas, with Swisspacer Ultimate plastic spacer.

2) Calculation method: Terrace system of size 2600x2250 mm, with steel reinforcement and glazed units $U_g = 0,5 \text{ W}/(\text{m}^2\text{K})$ infilled with argon gas, with Swisspacer Ultimate plastic spacer.



IGLO 5 PSK



IGLO 5 CLASSIC PSK



IGLO LIGHT PSK

Uw = 0,81 W/(m²K) ³	Uw = 0,81 W/(m²K) ³	Uw = 0,84 W/(m²K) ³
5	5	5
1 - white 2 - brown	1 - white 2 - brown	1 - white
no	yes	yes
Ug = 1.1 W/(m²K) 2-pane (1 chamber) units, infilled with argon gas, glass-pane spacer made of galvanised steel	Ug = 1.1 W/(m²K) 2-pane (1 chamber) units, infilled with argon gas, glass-pane spacer made of galvanised steel	Ug = 1.1 W/(m²K) 2-pane (1 chamber) units, infilled with argon gas, glass-pane spacer made of galvanised steel
24 - 40 mm	24 - 40 mm	24 - 40 mm
1 - 75 mm / 75 mm 2 - 80 mm / 78 mm	1 - 70 mm / 75 mm 2 - 70 mm / 78 mm	1 - 70 mm / 75 mm 2 - 70 mm / 78 mm
1 - 1.5 mm full (closed) 2 - 2 mm „c“-shaped	1 - 1.5 mm full (closed) 2 - 2 mm „c“-shaped	1 - 1.5 mm full (closed) 2 - 2 mm „c“-shaped
1 - MACO SKB-S Standard System 2 - MACO SKB-Z Automatic System	1 - MACO SKB-S Standard System 2 - MACO SKB-Z Automatic System	1 - MACO SKB-S Standard System 2 - MACO SKB-Z Automatic System
jamb frame	-	jamb frame

3) Calculation method: Terrace system of size 2600x2250 mm, with steel reinforcement and glazed units Ug = 0.7 W/(m²K) infilled with argon gas, with Swisspacer Ultimate plastic spacer.



ALUMINIUM WINDOWS

WOODEN WINDOWS





WOOD-ALUMINUM WINDOWS

D





ROLLER SHUTTERS, VENETIAN BLINDS, MOSQUITO NETS



D



DOORS

PVC
aluminium
wood

Drutex exterior doors mean very good thermal insulation parameters. various arrangement and functional possibilities as well as modern design and security. Highest quality components and equipment, used in the process of production, helped in creating product worthy of XXI century.

TERRACE SYSTEMS

PVC
aluminium
wood
wood aluminium

Unique design, ensuring a great access of daylight to the house and at the same time maintaining excellent parameters in terms of energy efficiency. Great configuration possibilities allow to cope with the most demanding customers. Application of our systems will not only add character to the usable area, but also make the building look more attractive from the outside





FACADES WINTER GARDENS

Aluminium facades and winter gardens are the perfect choice for fans of innovative technologies, various arrangement and utility possibilities as well as modern design combined with outstanding security. The latest technology of powder painting ensures material protection even in the most demanding environmental conditions. Combined with the wide RAL colour palette and wood-like colours it makes an exceptional offer on the global market of the aluminium window suite products.

Drutex is currently one of the leading producers of windows and doors in Europe. Not only, is it one of the most innovative and reliable polish brands, but also a calling card of polish entrepreneurship success' in the whole world.

The company, based in 100% on polish capital, from the beginning is managed by its founder, Leszek Gierszewski.

Thanks to the guaranteed high quality, rich offer, technological advancement, own laboratories, high efficiency of operation, really short lead and delivery time, year by year we grow our addressee net. Each product is custom-made and produced for a specific customer.

We offer PVC, aluminium, and wooden windows and doors, roller shutters, venetian blinds, facades, and winter gardens.

Window-door joinery, branded with the DRUTEX logo, reaches six continents.

We have been appreciated by millions of satisfied customers and independent experts, granting the company with many prestigious awards. The most important ones include: Forbes Diamond, EU Standard, European Medal, Superbrands Title, Plus X Award 2017.



up to 7000
windows daily



3850
employees



450
vehicles



110 M sq. m.
surface
production

Lead time even 7 days



since 1985





D



Quality

The latest technology, the best materials and production control at each stage, as well, as our own research laboratories are the guarantee of quality.



Security

The windows and terrace systems are equipped with reliable fittings and locks, which ensures security.



Service

Professional and fast service is Drutex's calling card, which has been setting trends in pre- and post- sale customer services for many years now.



Smart Home

Intelligent control of doors, windows, roller shutters, venetian blinds, mosquito nets, gates, wickets, and lighting by means of a smartphone.



Lęborska 31 Street, 77-100 Bytów
+48 59 822 91 01

————— **SINCE 1985** —————

The information presented in this advertising material are informative and illustrative only.
The product specification should be verified with the technical data specified by the manufacturer.